

# track



track



- \_\_\_\_\_ **finiure disponibili**
- \_\_\_\_\_ **available finishes**
- \_\_\_\_\_ **finiion disponibles**
- \_\_\_\_\_ **verfügbare Farben**
- \_\_\_\_\_ **available colours**
- \_\_\_\_\_
- \_\_\_\_\_ **10 Cromo - Chrome**
- \_\_\_\_\_ **Chrome - Chrom**





8



track track

track

9

Miscelatore monocomando per lavabo con scarico 1"1/4, tappo a cassetta totale.  
Single control mixer for washbasin, with pop up waste 1"1/4, total covering plate.  
Mixer monocommande de lavabo, vidage 1"1/4 avec bouchon à couvercle total.  
Wäschisch Einbedmischer mit Abflusgantrieb 1"1/4, komplett abdeckender Verschluss.  
Mixerador monocomando para lavabo con desagüe 1"1/4 y tapón a cubrimen total.

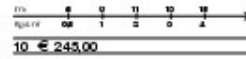

Miscelatore monocomando per lavabo senza scarico.  
Single control mixer for washbasin without waste.  
Mixer monocommande de lavabo sans vidage.  
Wäschisch Einbedmischer ohne Abflusgantrieb.  
Mixerador monocomando para lavabo sin desagüe.

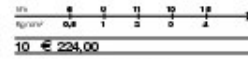

093010

093011

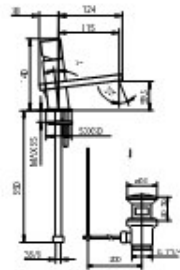

Miscelatore monocomando "hid" per lavabo con scarico 1"1/4, tappo a cassetta totale.  
"Hid" single control mixer for washbasin, with pop up waste 1"1/4, total covering plate.  
Mixer monocommande "hid" de lavabo, vidage 1"1/4 avec bouchon à couvercle total.  
"Hid" Wäschisch Einbedmischer mit Abflusgantrieb 1"1/4, komplett abdeckender Verschluss.  
Mixerador monocomando "hid" para lavabo con desagüe 1"1/4 y tapón a cubrimen total.

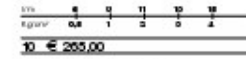

093085

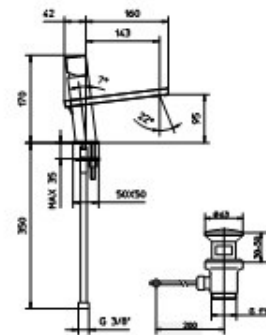

Miscelatore monocomando "hid" per lavabo senza scarico.  
"Hid" single control mixer for washbasin, without waste.  
Mixer monocommande "hid" de lavabo, sans vidage.  
"Hid" Wäschisch Einbedmischer ohne Abflusgantrieb.  
Mixerador monocomando "hid" para lavabo sin desagüe.

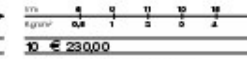

093086

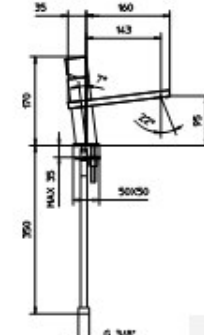



Miscelatore monocomando sterzo-atto per lavabo con scarico 1"1/4 Click-Click.  
 Superhigh single control mixer for washbasin Click-Click waste 1"1/4.  
 Mijgator monocomando sterzo-atto de lavabo avec vidage Click-Click 1"1/4.  
 Superhoch Waschtisch Einhebelmischer mit Click-Click Abflusganitur 1"1/4.  
 Mezclador monocomando sterzo-atto para lavabo con desagüe Click-Click 1"1/4.

Miscelatore monocomando sterzo-atto per lavabo, senza scarico.  
 Superhigh single control mixer for washbasin, without waste.  
 Mijgator monocomando sterzo-atto de lavabo, sans vidage.  
 Superhoch Waschtisch Einhebelmischer ohne Abflusganitur.  
 Mezclador monocomando sterzo-atto para lavabo, sin desagüe.

Miscelatore monocomando per bidet con scarico 1"1/4, tappo a cassetta totale.  
 Single control mixer for bidet, with pop-up waste 1"1/4, total covering flap.  
 Mijgator monocomando de bidet, sigilla 1"1/4 avec bouchon à cassette totale.  
 Misch Einhebelmischer, Abflusganitur 1"1/4, komplett deckender Ventildeckel.  
 Mezclador monocomando para bidet con desagüe 1"1/4 y tapón a cassetta total.

Miscelatore monocomando per bidet senza scarico.  
 Single control mixer for bidet, without waste.  
 Mijgator monocomando de bidet, sans vidage.  
 Misch Einhebelmischer ohne Abflusganitur.  
 Mezclador monocomando para bidet sin desagüe.

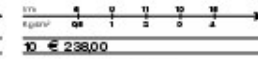
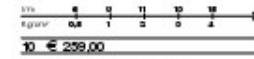
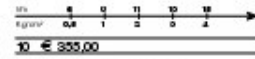
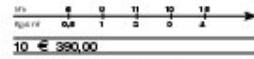

093079

093080

094010

094011

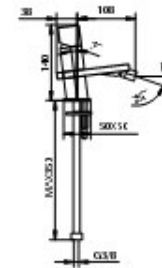
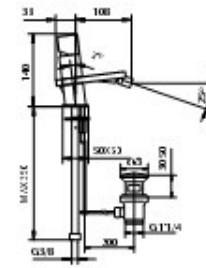
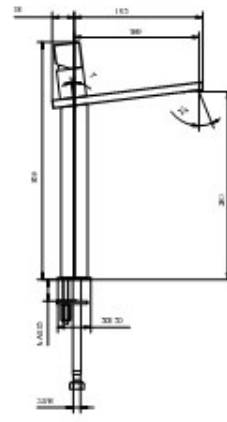
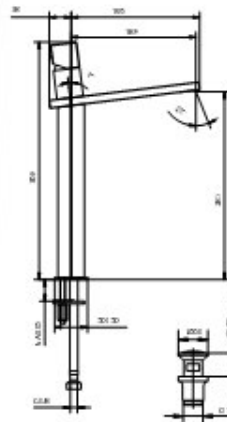

Miscelatore monocomando per vasca con diletatore, supporto doccia integrato, supporto doccia mobile flessibile Glas 1,5m e doccia.

Wall mounted bath-shower mixer with diverter, built-in shower bracket, wall mounted extend. bracket with Glas flexible tube 1,5m and handshower.

Mixer a monocomando da bagno dattore con supporto doccia incorporato, flessibile Glas 1,5m, doccia e supporti doccia orientabili.

Dach: Duschschleifer, Aufsatz mit eingebautes Brausehalter mit Glas Brause-schlauch 1,5 m, Handbrause und verstellbare Brausehalter.

Miscelador monocomando para bañera con divisor, soporte de ducha integrado, soporte de ducha orientable, flexible Glas 1,5m y ducha de mano.

Miscelatore monocomando per vasca con diletatore, supporto doccia integrato, flessibile Glas 1,5m e doccia.

Wall mounted bath-shower mixer with diverter, built-in shower bracket, Glas flexible tube 1,5m and handshower.

Mixer a monocomando da bagno dattore con supporto doccia incorporato, flessibile Glas 1,5m e doccia.

Dach: Duschschleifer, Aufsatz mit eingebautes Brausehalter, Glas Brause-schlauch 1,5 m und Handbrause.

Miscelador monocomando para bañera con divisor, soporte de ducha integrado, flexible Glas 1,5m y ducha de mano.

Miscelatore monocomando per vasca con diletatore, supporto doccia integrato, senza flessibile e doccia.

Wall mounted bath-shower mixer with diverter, built-in shower bracket, without shower fl.

Mixer a monocomando da bagno dattore con supporto doccia incorporato senza dattore flessibile.

Dach: Einbauschleifer, Aufsatz mit eingebautes Brausehalter ohne Handbrause und ohne Brause-schlauch.

Miscelador monocomando para bañera con divisor, soporte de ducha integrado sin flexible ni ducha de mano.

10 € 530,00

10 € 455,00

10 € 415,00

091025

091015

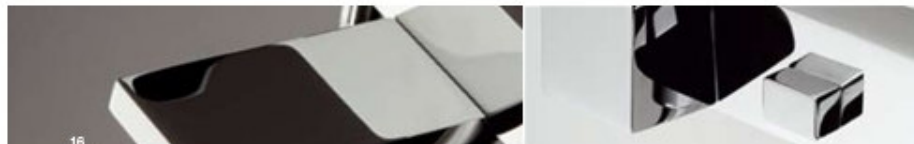
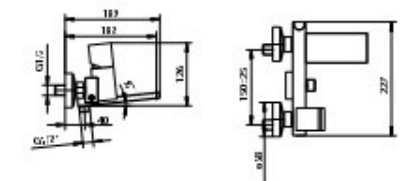
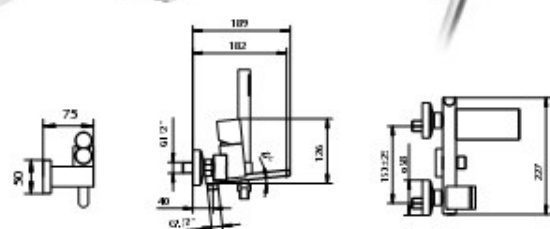
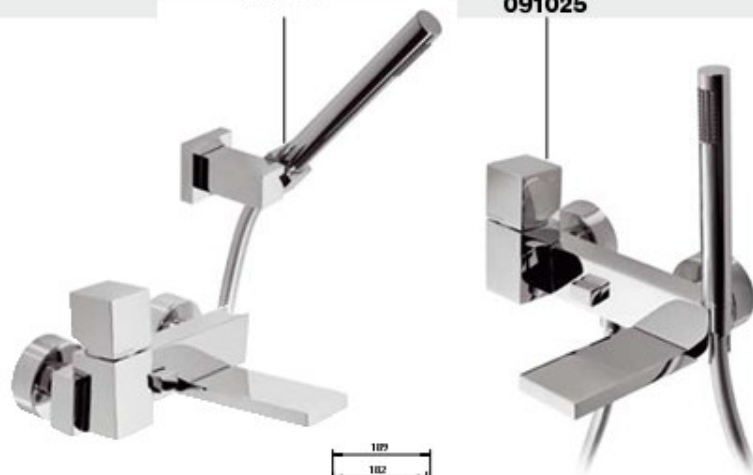



# click



finitura disponibili \_\_\_\_\_  
available finishes \_\_\_\_\_  
finition disponibles \_\_\_\_\_  
verfügbare Farben \_\_\_\_\_  
acabados disponibles \_\_\_\_\_

10 Cromo - Chrome \_\_\_\_\_  
Chromé - Chrom \_\_\_\_\_



Miscelatore monocomando per lavabo con acciaio da 1" 1/4.  
Single control mixer for washbasin, with pop up waste 1" 1/4.  
Mixer monocommande de lavabo avec vidage 1" 1/4.  
Waschtisch Einhebelmischer mit Abflusgantrieb 1" 1/4.  
Mezclador monomando para lavabo con desague 1" 1/4.

Miscelatore monocomando per lavabo senza scarico.  
Single control mixer for washbasin, without waste.  
Mixer monocommande de lavabo, sans vidage.  
Waschtisch Einhebelmischer ohne Abflusgantrieb.  
Mezclador monomando para lavabo sin desague.

Miscelatore monocomando per lavabo con acciaio da 1" 1/4, bocca profilata 175 mm.  
Single control mixer for washbasin, with pop up waste 1" 1/4, extended spout 175 mm.  
Mixer monocommande de lavabo, avec vidage 1" 1/4, bec 175 mm.  
Waschtisch Einhebelmischer mit Abflusgantrieb 1" 1/4, Abflus 175 mm.  
Mezclador monomando para lavabo con desague 1" 1/4, codo perfilado mm 175.

Miscelatore monocomando per lavabo senza scarico, con bocca profilata 175 mm.  
Single control mixer for washbasin, without waste, extended spout 175 mm.  
Mixer monocommande de lavabo sans vidage, bec 175 mm.  
Waschtisch Einhebelmischer ohne Abflusgantrieb, Abflus 175 mm.  
Mezclador monomando para lavabo sin desague con perfilado mm 175.

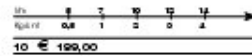

373010

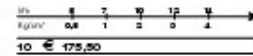
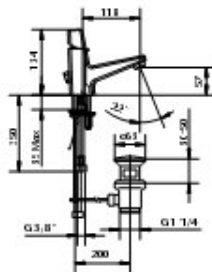

373011

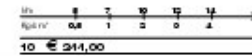
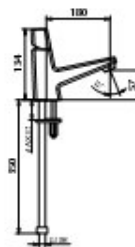

373038

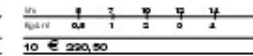
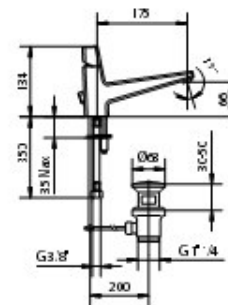

373045

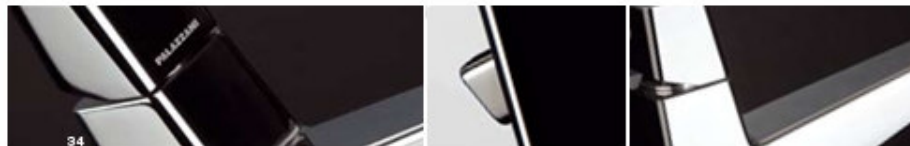
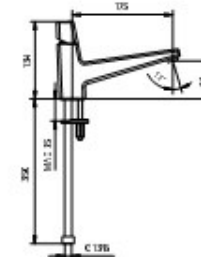

click

Miscelatore monocomando alto per lavabo con acciaio 1" 1/4 Click-Click.  
Tall single control mixer for washbasin, Click-Click waste 1" 1/4.  
Mixerre monocomando hant de lavabo, avec dégrée Click-Click 1" 1/4.  
Hoch Waschtisch Einheitsmischer mit Click-Click Abflusganitur 1" 1/4.  
Mezclador monocomando alto para lavabo con desgrée Click-Click 1" 1/4.

Miscelatore monocomando alto per lavabo acciaio acciaio.  
Tall single control mixer for washbasin, without waste.  
Mixerre monocomando hant de lavabo, sans dégrée.  
Hoch Waschtisch Einheitsmischer ohne Abflusganitur.  
Mezclador monocomando alto para lavabo, sin desgrée.

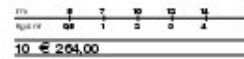
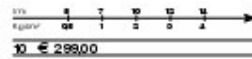

373077

373018

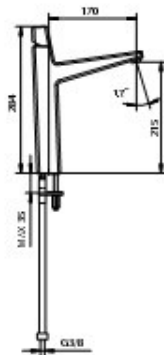
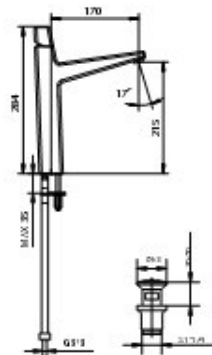

Miscelatore monocomando di incasso, per lavabi.  
Single control mixer for washbasin, concealed installation.  
Mixerre monocomando de incasso mixer pour lavabo.  
Einheitsmischer für Waschtisch Unterputz.  
Mezclador monocomando encastrable para lavabi.

Miscelatore monocomando per bidet con acciaio 1" 1/4.  
Single control mixer for bidet, with pop-up waste 1" 1/4.  
Mixerre monocomando de bidet, avec dégrée 1" 1/4.  
Bidet Einheitsmischer mit Abflusganitur 1" 1/4.  
Mezclador monocomando para bidet con desgrée 1" 1/4.

Miscelatore monocomando per bidet senza acciaio.  
Single control mixer for bidet, without waste.  
Mixerre monocomando de bidet, sans dégrée.  
Bidet Einheitsmischer ohne Abflusganitur.  
Mezclador monocomando para bidet sin desgrée.

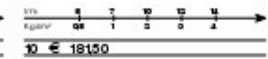
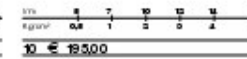
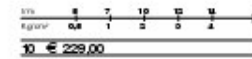

373081

374010

374011

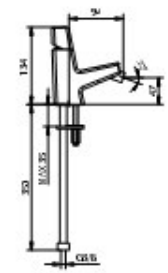
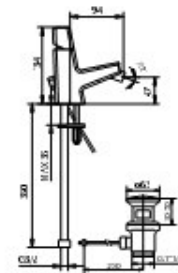
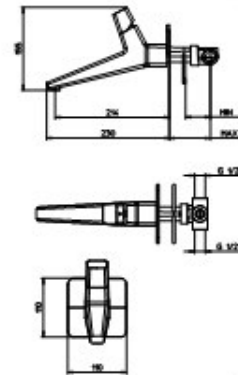

Miscelatore monocomando Full Contact per vasca con diffusore, supporto doccia integrato, supporto doccia orientabile, flessibile Glass 1,5m e doccia.

Wall mounted Full Contact bath-shower mixer with diffuser, built-in shower bracket, wall mounted shower bracket with Glass flexible tube 1,5m and handshower.

Miscelator monocomando Full Contact de baie-douches avec support douche intégré, flexible Glass 1,5m et douche.

Bade-Einheitsmischer Full Contact, Aufsatz mit eingebautem Brausehalter mit Glass Brause-schlauch 1,5m, Handbrause und verstellbarer Brausehalter.

Miscelador monocomando Full Contact para bañera con difusor, soporte de ducha integrado, soporte de ducha orientable, flexible Glass 1,5m y ducha de mano.

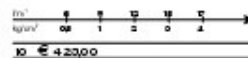

Miscelatore monocomando Full Contact per vasca con diffusore, supporto doccia integrato, flessibile Glass 1,5m e doccia.

Wall mounted Full Contact bath-shower mixer with diffuser, built-in shower bracket, Glass flexible tube 1,5m and handshower.

Miscelator monocomando Full Contact de baie-douches avec support douche incorporé, flexible Glass 1,5m et douche.

Bade-Einheitsmischer Full Contact, Aufsatz mit eingebautem Brausehalter, Glass Brause-schlauch 1,5 m und Handbrause.

Miscelador monocomando Full Contact para bañera con difusor, soporte de ducha integrado, flexible Glass 1,5m y ducha de mano.

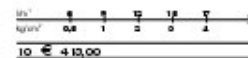

Miscelatore monocomando Full Contact per vasca con diffusore, supporto doccia integrato, supporto doccia orientabile, flessibile Glass 1,5m e doccia.

Wall mounted Full Contact bath-shower mixer with diffuser, built-in shower bracket, wall mounted shower bracket with Glass flexible tube 1,5m and handshower.

Miscelator monocomando Full Contact de baie-douches avec support douche intégré, flexible Glass 1,5m et douche.

Bade-Einheitsmischer Full Contact, Aufsatz mit eingebautem Brausehalter mit Glass Brause-schlauch 1,5 m, Handbrause und verstellbarer Brausehalter.

Miscelador monocomando Full Contact para bañera con difusor, soporte de ducha integrado, soporte de ducha orientable, flexible Glass 1,5m y ducha de mano.

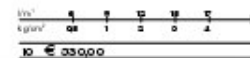

Miscelatore monocomando Full Contact per vasca con diffusore, supporto doccia integrato senza flessibile e doccia.

Wall mounted Full Contact bath-shower mixer with diffuser, built-in shower bracket without shower fl.

Miscelator monocomando Full Contact de baie-douches avec support douche incorporé sans flexible et douche.

Bade-Einheitsmischer Full Contact, Aufsatz mit eingebautem Brausehalter, ohne Handbrause und ohne Duschschlauch.

Miscelador monocomando Full Contact para bañera con difusor, soporte de ducha integrado sin flexible ni ducha de mano.

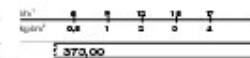

371012

371025

371096

371015

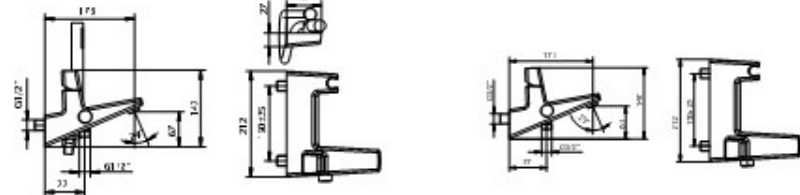
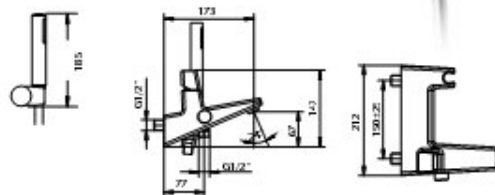



Miscelatore monocomando di incasso completo per vasca doccia con diffusore automatico.  
 Complete concealed single lever mixer for bath shower with automatic diverter.  
 Mijestri monocomande à encastrer complet pour bain douche avec inverseur automatique.  
 Komplett Unterputz-Wannen- und Brausenstrahlmischer.  
 Mezclador monocomando empotrable para bañoducha con desviador automático.

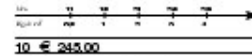

371020



UNICO 3, corpo di incasso per miscelatore monocomando vasca doccia con diffusore automatico senza parti esterne.  
 UNICO 3, concealed body for bathshower with automatic diverter without exposed parts.  
 UNICO 3, corps de mjectri monocomande à encastrer de bain douche avec inverseur sans parties extérieures.  
 UNICO 3, Unterputz-Körper für Wannen- und Brausenstrahlmischer mit Umsteller, ohne Ausputzteil.  
 UNICO 3, cuerpo de mezclador monocomando empotrable para bañoducha con desviador automático sin partes externas.

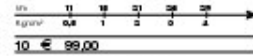

992727



Solo parti esterne per miscelatore monocomando vasca doccia con diffusore.  
 Exposed parts only for bathshower concealed mixer with automatic diverter.  
 Parties extérieures seule pour mjectri monocomande de bain douche avec inverseur automatique.  
 Ausputzteile Wannen- und Brausenstrahlmischer mit Umsteller.  
 Partes externas de mezclador monocomando empotrable para bañoducha con desviador automático.

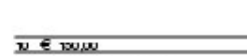

371021



Miscelatore monocomando di incasso completo per doccia.  
 Complete concealed single lever mixer for shower.  
 Mijestri monocomande complet à encastrer pour douche.  
 Komplett Unterputz-Brausenstrahlmischer.  
 Mezclador monocomando empotrable completo para ducha.

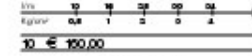

372010



UNICO 3, corpo di incasso per miscelatore monocomando per doccia, senza parti esterne.  
 UNICO 3, concealed body for shower without exposed parts.  
 UNICO 3, corps de mjectri monocomande à encastrer pour douche, sans parties extérieures.  
 UNICO 3, Unterputzkörper für Brausenstrahlmischer ohne Ausputzteil.  
 UNICO 3, cuerpo de mezclador monocomando empotrable para ducha, sin partes externas.

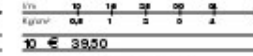

992726



Solo parti esterne per miscelatore monocomando di incasso per doccia.  
 Exposed parts only for shower concealed mixer.  
 Parties extérieures seule pour mjectri monocomande à encastrer pour douche.  
 Ausputzteile Wannen-Brausenstrahlmischer.  
 Solo partes externas para mezclador monocomando empotrable para ducha.

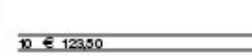

372011



Miscelatore monocomando di incasso completo per doccia in POLIPROPILENE.  
 POLIPROPILENE concealed complete shower mixer.  
 Mijestri monocomande à encastrer pour douche complet en POLIPROPILENE.  
 Unterputz-Einlehebrausenstrahlmischer für Dusche aus POLIPROPILENE.  
 Mezclador monocomando empotrable completo para ducha de POLIPROPILENE.

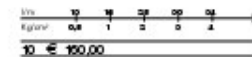

372910

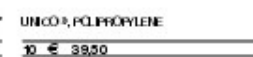

992732

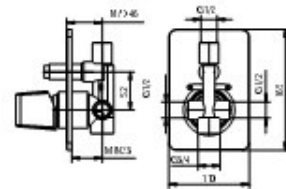
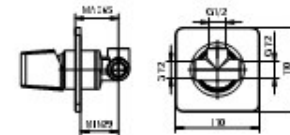

click

Miscelatore monocomando da incasso  
multi funzione con distatore a dadi in  
ceramica, 2 uscite.  
Concealed single control mixer, multifunction  
with ceramic disc 2 outlets cluster.  
Mixer monocommande à encastrer,  
multi fonction avec levacrot à disques en  
céramique, 2 sorties.  
Unterputz Einbaubehälter Multifunktion mit  
Keramik 2-Ausgangsmischer.  
Mezclador monomando para empotrar con  
distador a discos de cerámica a 2  
salidas.

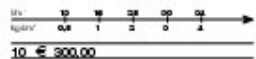

372062

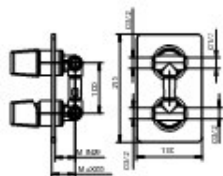

Miscelatore monocomando da incasso  
multi funzione con distatore a dadi in  
ceramica, 3 uscite.  
Concealed single control mixer, multifunction  
with ceramic disc 3 outlets cluster.  
Mixer monocommande à encastrer,  
multi fonction avec levacrot à disques en  
céramique, 3 sorties.  
Unterputz Einbaubehälter Multifunktion mit  
Keramik 3-Ausgangsmischer.  
Mezclador monomando para empotrar con  
distador a discos de cerámica a 3 salidas.

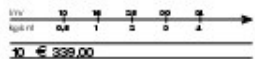

372063

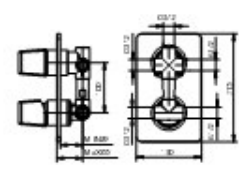

Miscelatore monocomando da incasso  
multi funzione con distatore a dadi in  
ceramica, 4 uscite.  
Concealed single control mixer, multifunction  
with ceramic disc 4 outlets cluster.  
Mixer monocommande à encastrer,  
multi fonction avec levacrot à disques en  
céramique, 4 sorties.  
Unterputz Einbaubehälter Multifunktion mit  
Keramik 4-Ausgangsmischer.  
Mezclador monomando para empotrar con  
distador a discos de cerámica a 4 salidas.

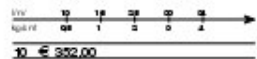

372064

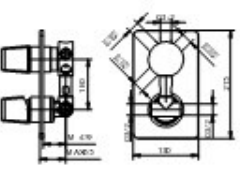

Miscelatore monocomando da incasso  
multi funzione con distatore a dadi in  
ceramica, 5 uscite.  
Concealed single control mixer, multifunction  
with ceramic disc 5 outlets cluster.  
Mixer monocommande à encastrer,  
multi fonction avec levacrot à disques en  
céramique, 5 sorties.  
Unterputz Einbaubehälter Multifunktion mit  
Keramik 5-Ausgangsmischer.  
Mezclador monomando para empotrar con  
distador a discos de cerámica a 5 salidas.

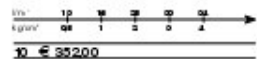

372065

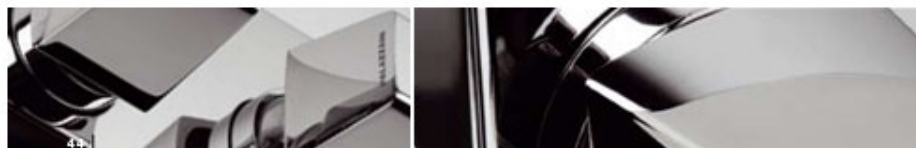
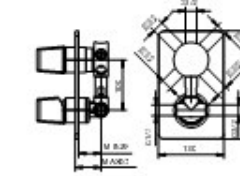

click

UNICO®, corpo per miscelatore monocomando di lavaso multifunzione con deviatore a dischi in ceramica, 2 uscite.  
 UNICO®, body for concealed single control mixer, multifunction with ceramic disc deviator, 2 outlets.  
 UNICO®, corps pour mélangeur monocommande à encastre multifonction avec inverseur à disques en céramique, 2 sorties.  
 UNICO®, Körper für Unterputz Einhandmischer Multifunktion mit Keramik 2-Wegeventilsteile.  
 UNICO®, corpo de mezclador monomando para empotrar con desviador de disco de cerámica a 2 salidas.

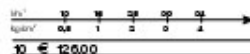

992739



Solo parti esterne - Exposed parts only  
 Parties extérieures seule - Außenstücke  
 Partes externas

10 € 178,00

UNICO®, corpo per miscelatore monocomando di lavaso multifunzione con deviatore a dischi in ceramica, 3 uscite.  
 UNICO®, body for concealed single control mixer, multifunction with ceramic disc deviator, 3 outlets.  
 UNICO®, corps pour mélangeur monocommande à encastre multifonction avec inverseur à disques en céramique, 3 sorties.  
 UNICO®, Körper für Unterputz Einhandmischer Multifunktion mit Keramik 3-Wegeventilsteile.  
 UNICO®, corpo de mezclador monomando para empotrar con desviador de disco de cerámica a 3 salidas.

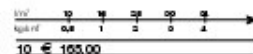

992740



Solo parti esterne - Exposed parts only  
 Parties extérieures seule - Außenstücke  
 Partes externas

10 € 178,00

UNICO®, corpo per miscelatore monocomando di lavaso multifunzione con deviatore a dischi in ceramica, 4 uscite.  
 UNICO®, body for concealed single control mixer, multifunction with ceramic disc deviator, 4 outlets.  
 UNICO®, corps pour mélangeur monocommande à encastre multifonction avec inverseur à disques en céramique, 4 sorties.  
 UNICO®, Körper für Unterputz Einhandmischer Multifunktion mit Keramik 4-Wegeventilsteile.  
 UNICO®, corpo de mezclador monomando para empotrar con desviador de disco de cerámica a 4 salidas.

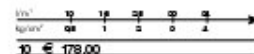

992744



Solo parti esterne - Exposed parts only  
 Parties extérieures seule - Außenstücke  
 Partes externas

10 € 178,00

UNICO®, corpo per miscelatore monocomando di lavaso multifunzione con deviatore a dischi in ceramica, 5 uscite.  
 UNICO®, body for concealed single control mixer, multifunction with ceramic disc deviator, 5 outlets.  
 UNICO®, corps pour mélangeur monocommande à encastre multifonction avec inverseur à disques en céramique, 5 sorties.  
 UNICO®, Körper für Unterputz Einhandmischer Multifunktion mit Keramik 5-Wegeventilsteile.  
 UNICO®, corpo de mezclador monomando para empotrar con desviador de disco de cerámica a 5 salidas.

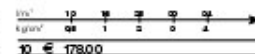

992745



Solo parti esterne - Exposed parts only  
 Parties extérieures seule - Außenstücke  
 Partes externas

10 € 178,00

372102



372103



372104



372105

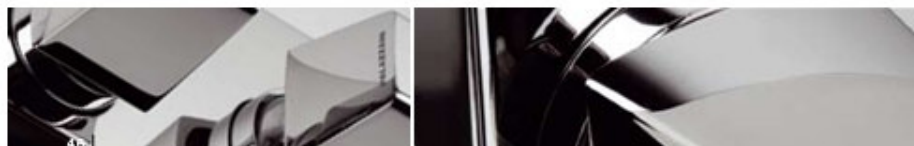

click



finire disponibili  
available finishes  
finition disponibles  
verfignare Finishen  
statistatus disponibiles

---

10 Cromo - Chrome  
Chromé - Chrom



Miscelatore monocomando per lavabo con acciaio da 1" 1/4.  
Single control mixer for washbasin, with pop up waste 1" 1/4.  
Mixer monocommande de lavabo avec vidage 1" 1/4.  
Waschtisch Einhebelmischer mit Abflusganitur 1" 1/4.  
Mezclador monomando para lavabo con desagüe 1" 1/4.

Miscelatore monocomando per lavabo senza scarico.  
Single control mixer for washbasin, without waste.  
Mixer monocommande de lavabo, sans vidage.  
Waschtisch Einhebelmischer ohne Abflusganitur.  
Mezclador monomando para lavabo sin desagüe.

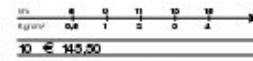
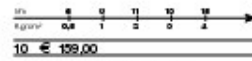

563010

563011

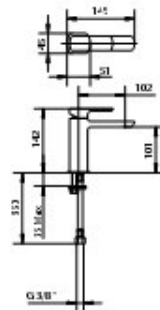
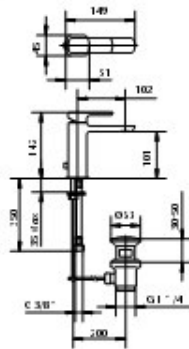

Miscelatore monocomando per lavabo con acciaio da 1" 1/4, bocca prolungata 122 mm.  
Single control mixer for washbasin, with pop up waste 1" 1/4, extended spout 122 mm.  
Mixer monocommande de lavabo, avec vidage 1" 1/4, bec 122 mm.  
Waschtisch Einhebelmischer mit Abflusganitur 1" 1/4, Auslauf 122 mm.  
Mezclador monomando para lavabo con desagüe 1" 1/4, corno prolongado mm 122.

Miscelatore monocomando per lavabo senza scarico, con bocca prolungata 122 mm.  
Single control mixer for washbasin, without waste, extended spout 122 mm.  
Mixer monocommande de lavabo sans vidage, bec 122 mm.  
Waschtisch Einhebelmischer ohne Abflusganitur, Auslauf 122 mm.  
Mezclador monomando para lavabo sin desagüe cono prolongado mm 122.

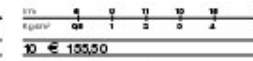
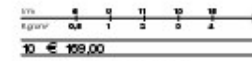

563083

563084

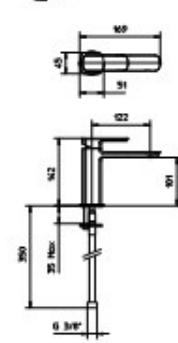
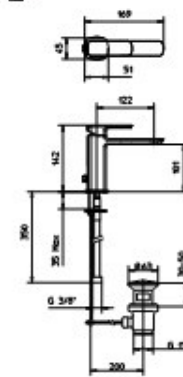

Miscelatore monocomando per lavabo con acciaio da 1" 1/4, bocca prolungata 202 mm.  
 Single control mixer for washbasin, with pop-up waste 1" 1/4, extended spout 202 mm.  
 Mischler monocomando de lavabo avec vidage, bec 202 mm.  
 Waschtisch Einhebelmischer mit Abflusgarnitur 1" 1/4, Ausläß 202 mm.  
 Mezclador monocomando para lavabo con desagüe con prolongado mm 202

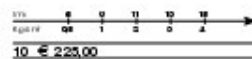

563038

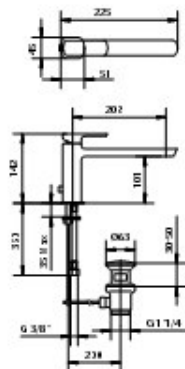

Miscelatore monocomando per lavabo acciaio acciaio, con bocca prolungata 202 mm.  
 Single control mixer for washbasin, without waste, extended spout 202 mm.  
 Mischler monocomando de lavabo sans vidage, bec 202 mm.  
 Waschtisch Einhebelmischer ohne Abflusgarnitur, Ausläß 202 mm.  
 Mezclador monocomando para lavabo sin desagüe con prolongado mm 202

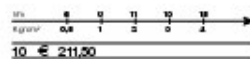

563045

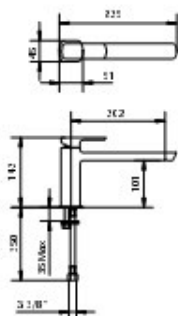

Miscelatore monocomando alto per lavabo con acciaio 1" 1/4.  
 Tall single control mixer for washbasin, with pop-up waste 1" 1/4.  
 Mischler monocomando alto de lavabo avec vidage 1" 1/4.  
 Hoch Waschtisch Einhebelmischer mit Abflusgarnitur 1" 1/4.  
 Mezclador monocomando alto para lavabo con desagüe 1" 1/4

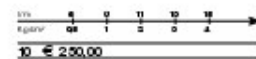

563013

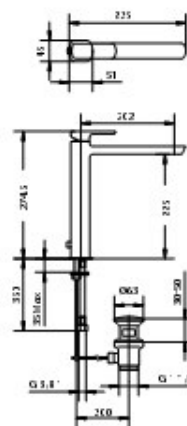

Miscelatore monocomando alto per lavabo acciaio acciaio.  
 Tall single control mixer for washbasin, without waste.  
 Mischler monocomando alto de lavabo sans vidage.  
 Hoch Waschtisch Einhebelmischer ohne Abflusgarnitur.  
 Mezclador monocomando alto para lavabo sin desagüe

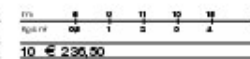

563018

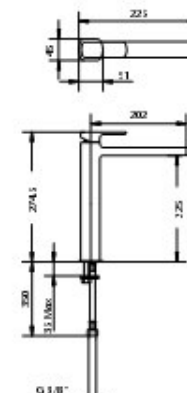

Miscelatore monocomando da incasso per lavabo.  
Single control mixer for washbasin, concealed installation.  
Mixer monocomando a incasso mural per lavabo.  
Einhebelmischer für Waschbecken, Unterputz.  
Mezclador monocomando empotrado para lavabo.

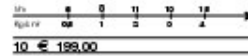

563081

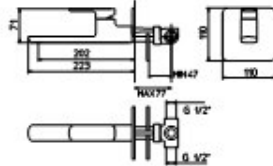

Miscelatore monocomando per bidet con scarico 1"1/4.  
Single control mixer for bidet, with pop up waste 1"1/4.  
Mixer monocomando de bidet, avec vidage 1"1/4.  
Bidet Einhebelmischer mit Abflusgarmitur 1"1/4.  
Mezclador monocomando para bidet con desague 1"1/4.

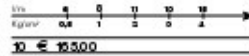

564010

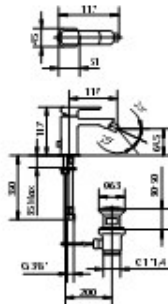

Miscelatore monocomando per bidet senza scarico.  
Single control mixer for bidet, without waste.  
Mixer monocomando de bidet, sans vidage.  
Bidet Einhebelmischer ohne Abflusgarmitur.  
Mezclador monocomando para bidet sin desague.

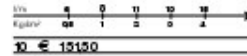

564011

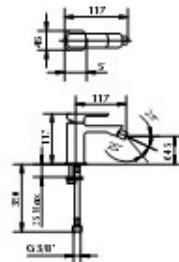

Batelia borb vasca 3 fori, vitoli a diadi in ceramica a 180°.  
Deck mounted 3 holes bath mixer, ceramic deck hand valves 180°.  
Mixer a 3 fori con grappe da bagno, testee ceramiche 180°.  
Wannenrand-Fürbischhähne mit keramischen Oberteile 180°.  
Batelia desobregoner para banera 3 agujeros, con elicos de ceramica 180°.

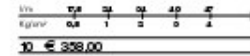

011013

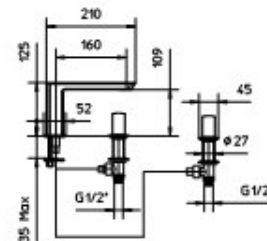

Batelia borb vasca 5 fori con desatore, doccia e lavabi, vitoli a diadi in ceramica a 180°.  
Deck mounted 5 holes bath mixer with shower and shower lift, ceramic deck valves 180°.  
Mixer a 5 fori con grappe da bagno, avec lavetoy et combine de douches, testee ceramiche 180°.  
Wannenrand-Fürbischhähne mit Handteller, Badegarnitur, mit keramischen Oberteile 180°.  
Batelia desobregoner para banera 5 agujeros, testee y ducha de mano con elicos de ceramica 180°.

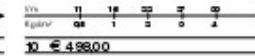

011384

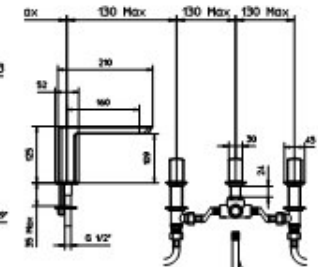

mis

Miscelatore monocomando per vasca con  
bocca d'isolaro, supporto doccia integrato,  
supporto doccia orientabile, flessibile Glass  
1,5m e doccia.

Wall mounted bath shower mixer with  
diverter spout, bath in shower bracket, wall  
mounted angled shower bracket, Glass flexible  
tube 1,5m and handshower.

Miscelatore monocomando da parete con  
bocca d'isolaro, supporto doccia  
integrato, flessibile Glass 1,5m, doccia e  
supporto doccia orientabile.

Bade-Einzelmischer mit Umsteller-Auslass  
-Auslass, eingebautem Brausehalter mit Glass  
Brause Schlauch 1,5m, Handbrause und  
verstellbarer Brausehalter.

Mezclador monocomando para bañera con  
caño desviador, soporte de ducha integrado,  
soporte de ducha orientable, flexible Glass  
1,5m y ducha de mano.

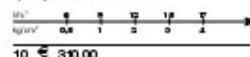

Miscelatore monocomando per vasca con  
bocca d'isolaro, supporto doccia integrato,  
flessibile Glass 1,5m e doccia.

Wall mounted bath shower mixer, with  
diverter spout, bath in shower bracket, Glass  
flexible tube 1,5m and handshower.

Miscelatore monocomando da baia doccia,  
bocca d'isolaro, supporto doccia  
integrato, flessibile Glass 1,5m, doccia.

Bade-Einzelmischer mit Umsteller-Auslass  
-Auslass, eingebautem Brausehalter mit Glass  
Brause Schlauch 1,5 m und Handbrause.

Mezclador monocomando para bañera con  
caño desviador, soporte de ducha integrado,  
flexible Glass 1,5m y ducha de mano.

Mezclador monocomando para bañera con  
caño desviador, soporte de ducha integrado,  
flexible Glass 1,5m y ducha de mano.

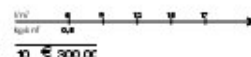

561012

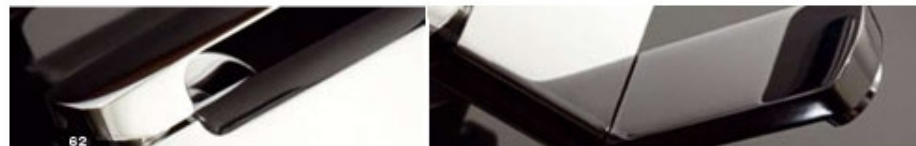
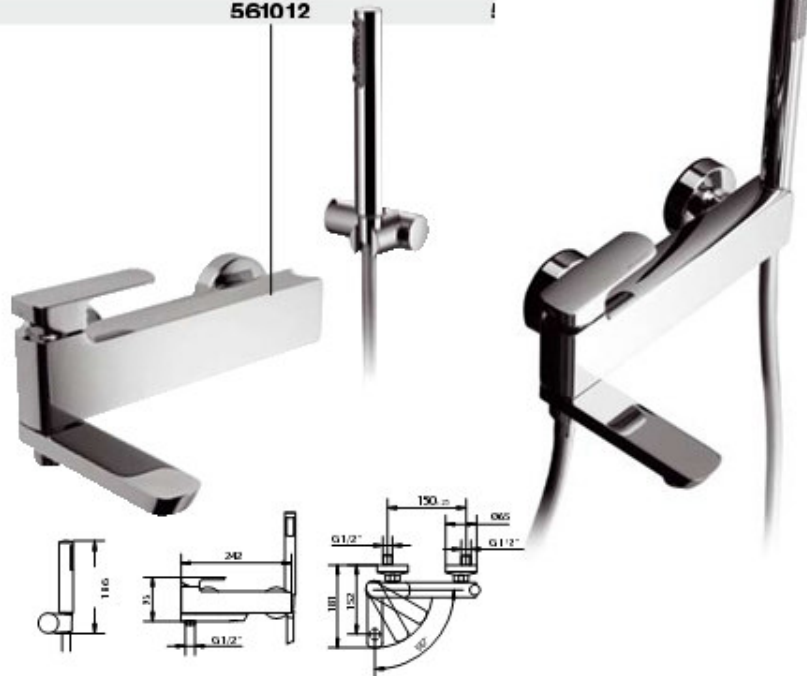

Miscelatore monocomando per vasca con  
bocca d'isolaro, supporto doccia integrato  
senza flessibile né doccia.

Wall mounted bath shower mixer with diverter  
spout, bath in shower bracket, without shower  
bit.

Miscelatore monocomando da baia doccia,  
bocca d'isolaro, supporto doccia  
integrato, senza flessibile né doccia.

Bade-Einzelmischer mit Umsteller-Auslass  
-Auslass, eingebautem Brausehalter ohne  
Handbrause und ohne Brause Schlauch.

Mezclador monocomando para bañera con  
caño desviador, soporte de ducha integrado,  
sin flexible ni ducha de mano.

Mezclador monocomando para bañera con  
caño desviador, soporte de ducha integrado,  
sin flexible ni ducha de mano.

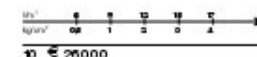

561015

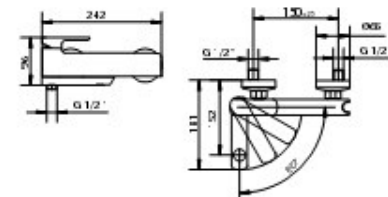

mis mis

Miscelatore monocomando per doccia, supporto doccia integrato, supporto doccia orientabile, flessibile Glass 1,5m e doccia.  
 Wall mounted shower mixer, built-in shower bracket, wall mounted toilet bracket, Glass flexible tube 1,5m and handshower.

Mixer monocommande de douche avec support douche intégré, douche flexible Glass 1,5m et support mural orientable.

Bauste-Einhebelmischer, Armatur mit eingebautem Brausehalter, Glas Brause-schlauch 1,5 m, Handbrause und verstellbare Brausehalter.

Miscelador monocomando para ducha, soporte de ducha integrado y soporte de ducha orientable, flexible Glass 1,5m y ducha de mano.

10 € 245,00

562020

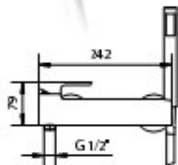
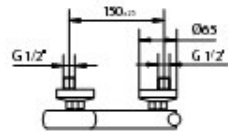

Miscelatore monocomando per doccia, supporto doccia integrato con flessibile Glass 1,5m e doccia.  
 Wall mounted shower mixer, built-in shower bracket, with Glass flexible tube 1,5m and handshower.

Mixer monocommande de douche avec support douche intégré avec flexible Glass 1,5m et douchette.

Bauste-Einhebelmischer, Armatur mit eingebautem Brausehalter, Glas Brause-schlauch 1,5 m und Handbrause.

Miscelador monocomando para ducha, soporte de ducha integrado, flexible Glass 1,5m y ducha de mano.

10 € 238,00

562027



Miscelatore monocomando per doccia, supporto doccia integrato, senza flessibile e no doccia.  
 Wall mounted shower mixer, built-in shower bracket, without shower kit.

Mixer monocommande de douche avec support douche intégré, sans douche et ni flexible.

Bauste-Einhebelmischer, Armatur mit eingebautem Brausehalter ohne Handbrause und ohne Brause-Schlauch.

Miscelador monocomando para ducha, soporte de ducha integrado, sin flexibles ducha de mano.

10 € 185,00

562026

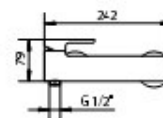
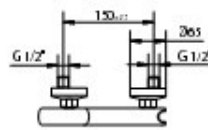

Miscelatore monocomando di incasso completo per vasca doccia con diffusore automatico.  
 Complete concealed single lever mixer for bath/shower with automatic diverter.  
 Mixer monocomando a incasso completo per bath doccia con diffusore automatico.  
 Komplet Uniputz-Wannen- und Brausen-Einbaumischer.  
 Mesclador monocomando empotrable para bañador/baño completo con difusor automático.

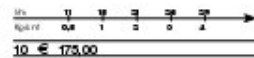

561020

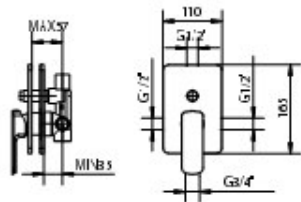

Miscelatore monocomando di incasso completo per doccia.  
 Complete concealed single lever mixer for shower.  
 Mixer monocomando completo a incasso per doccia.  
 Komplet Uniputz-Brausen-Einbaumischer.  
 Mesclador monocomando empotrable completo para ducha.

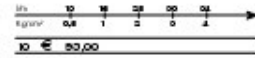

562010

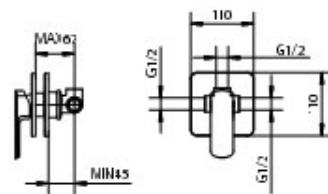



digit 2

finiture disponibili  
available finishes  
finition disponibles  
verfügbare Farben  
acabados disponibles

10 Cromo - Chrome  
Chromé - Chrom



PALAZZANI PROJECT 89

Miscelatore monocomando per lavabo con scarico da 1" 1/4.  
Single control mixer for washbasin, with pop-up waste 1" 1/4.  
Mixer monocommande de lavabo avec vidage 1" 1/4.  
Waschtisch Einhebelmischer mit Abflusgantrieb 1" 1/4.  
Mezclador monocomando para lavabo con desagüe 1" 1/4.

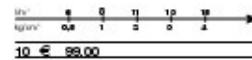

103010

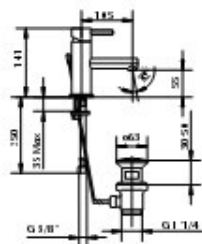

Miscelatore monocomando per lavabo senza scarico.  
Single control mixer for washbasin without waste.  
Mixer monocommande de lavabo sans vidage.  
Waschtisch Einhebelmischer ohne Abflusgantrieb.  
Mezclador monocomando para lavabo sin desagüe.

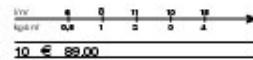

103011

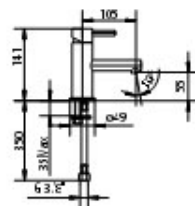

Miscelatore monocomando per lavabo ad incasso parete, con anelli di copertura bocca 22 cm.  
Single control mixer for washbasin, concealed installation, with cover rings, spout of 22 cm.  
Mixer monocommande de lavabo à encastrer mural, avec raiaces bec de 22 cm.  
Einhebelmischer für Waschtisch zum Wandkitchen mit Abfluslöcher, Auslauf 22 cm.  
Mezclador monocomando para lavabo empotrable con anillos, boca de 22 cm.

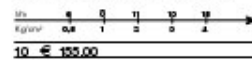

123114

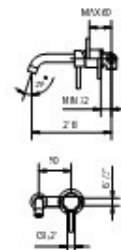

Miscelatore monocomando per lavabo con scarico da 1" 1/4, bocca protetta 135 mm.  
Single control mixer for washbasin, with pop-up waste 1" 1/4, extended spout 135 mm.  
Mixer monocommande de lavabo, avec vidage 1" 1/4, bec 135 mm.  
Waschtisch Einhebelmischer mit Abflusgantrieb 1" 1/4, Auslauf 135 mm.  
Mezclador monocomando para lavabo, con desagüe 1" 1/4, boca protegida mm 135.

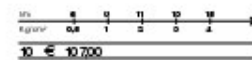

103038

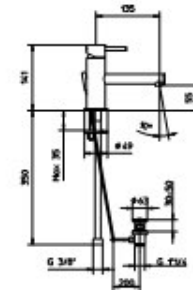

Miscelatore monocomando per lavabo senza scarico con bocca protetta 135 mm.  
Single control mixer for washbasin, without waste, extended spout 135 mm.  
Mixer monocommande de lavabo, sans vidage, bec 135 mm.  
Waschtisch Einhebelmischer ohne Abflusgantrieb, Auslauf 135 mm.  
Mezclador monocomando para lavabo, sin desagüe, boca protegida mm 135.

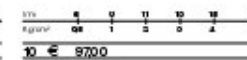

103045

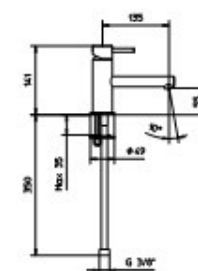

Miscelatore monocomando per lavabo bocca fissa con scarico 1" 1/4.  
Single control mixer for washbasin, fixed spout with pop-up waste 1" 1/4.  
Mixer monocommande de lavabo, bec fixe avec vidage 1" 1/4.  
Waschtisch Einhebelmischer mit Auslauf und Abflusgantrieb 1" 1/4.  
Mezclador monocomando para lavabo con boca fija y desagüe 1" 1/4.

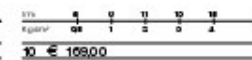

123063

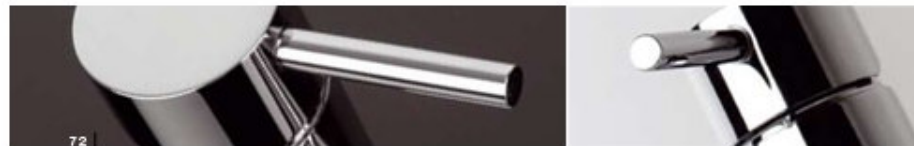
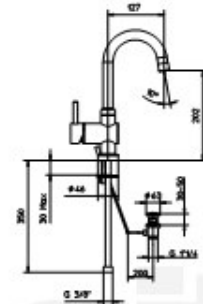

Miscelatore monocomando alto per lavabo con scarico 1" 1/4 Click-Click.  
 Tall single control mixer for washbasin, Click-Click waste 1" 1/4.  
 Mijgstr monocomando hatt de lavabo, avec vilage Click-Click 1" 1/4.  
 Hoch Waschtisch Einheitsmischer mit Click-Click Abflusganitur 1" 1/4.  
 Mezclador monocomando alto para lavabo con desagüe Click-Click 1" 1/4.

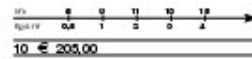

103077

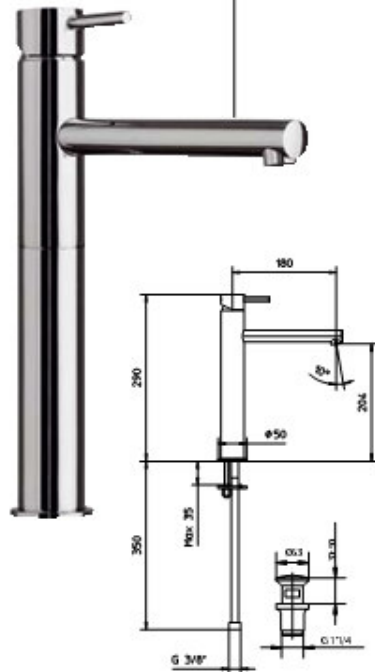

Miscelatore monocomando alto per lavabo senza scarico.  
 Tall single control mixer for washbasin, without waste.  
 Mijgstr monocomando hatt de lavabo, sans vilage.  
 Hoch Waschtisch Einheitsmischer ohne Abflusganitur.  
 Mezclador monocomando alto para lavabo, sin desagüe.

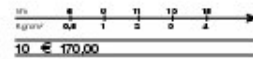

103018

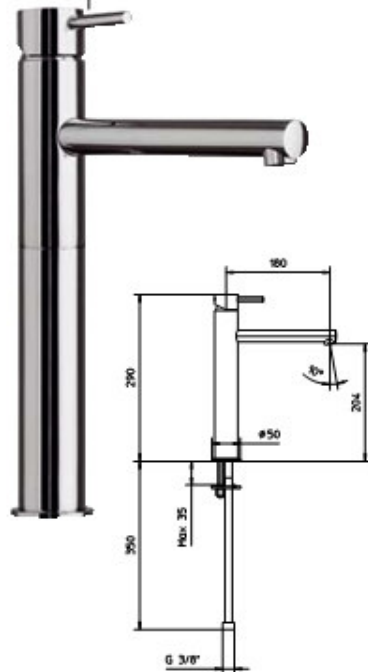

Miscelatore monocomando per bidet con scarico 1" 1/4.  
 Single control mixer for bidet, with pop-up waste 1" 1/4.  
 Mijgstr monocomando de bidet, avec vilage 1" 1/4.  
 Bidet Einheitsmischer mit Abflusganitur 1" 1/4.  
 Mezclador monocomando para bidet con desagüe 1" 1/4.

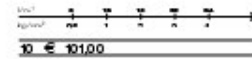

104010



Miscelatore monocomando per bidet senza scarico.  
 Single control mixer for bidet, without waste.  
 Mijgstr monocomando de bidet, sans vilage.  
 Bidet Einheitsmischer ohne Abflusganitur.  
 Mezclador monocomando para bidet sin desagüe.

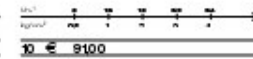

104011



Miscelatore monocomando per bidet, bocca fissa con scarico 1" 1/4.  
 Single control mixer for bidet, fixedspout with pop-up waste 1" 1/4.  
 Mijgstr monocomando de bidet, bocche avec vilage 1" 1/4.  
 Bidet Einheitsmischer mit fester und Abflusganitur 1" 1/4.  
 Mezclador monocomando para bidet, con boca fija con desagüe 1" 1/4.

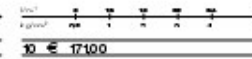

124043



Miscelatore monocomando per vasca con  
doccia, supporto doccia orientabile,  
flexibile 1,5m e doccia.

Wall mounted bath/shower mixer with  
diverter, adjust holder with flexible 1,5m  
and handshower.

Mixer monocomando de bain douche,  
flexible 1,5m, douche et support mural  
orientable.

Einhebelmischer für Wannen/Bathtub mit  
verstellbarer Brausehalter, Handbrause und  
Duschschlauch 1,5m.

Mesclador monocomando para bañera con  
desviador, soporte de ducha orientable,  
flexible 1,5m y ducha de mano.

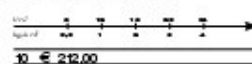

Miscelatore monocomando per vasca con  
doccia, supporto doccia flessibile  
1,5m e doccia.

Wall mounted bath/shower mixer, with  
diverter, flexible holder with flexible 1,5m  
and handshower.

Mixer monocomando de bain douche,  
flexible 1,5m, douche et support mural flex.

Einhebelmischer für Wannen/Bathtub mit  
flexiblem Brausehalter, Handbrause und  
Schlauch 1,5m.

Mesclador monocomando para bañera con  
desviador, soporte de ducha flexible 1,5m  
y ducha de mano.

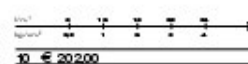

Miscelatore monocomando per vasca con  
doccia, senza flessibile né doccia.

Wall mounted bath/shower mixer with  
diverter, without shower fl.

Mixer monocomando de bain douche  
sans douche et flexible.

Einhebelmischer für Wannen/Bathtub mit  
Umsteller ohne Handbrause und ohne  
Duschschlauch.

Mesclador monocomando para bañera con  
desviador sin flexible ni ducha de mano.

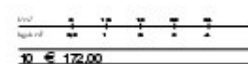

Kit separabdo vasca con pannello di  
miscelatore monocomando, distatore a due  
vie bocca e doccia.

Deck mounted kit composed by single  
control mixer two-ways diverter, spout and  
handshower.

Kit sur gouge composé par mixer  
monocomando, inverseur à deux voies, bec  
et douche.

Set für Wannen/Bathtub, bestehend aus  
Einhebelmischer mit Umsteller, Auslass und  
Handbrause.

Kit de solzenzer compuesto por mesclador  
monocomando con desviador, cano y ducha de  
mano.

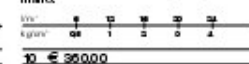

101012

101010

101015

121089

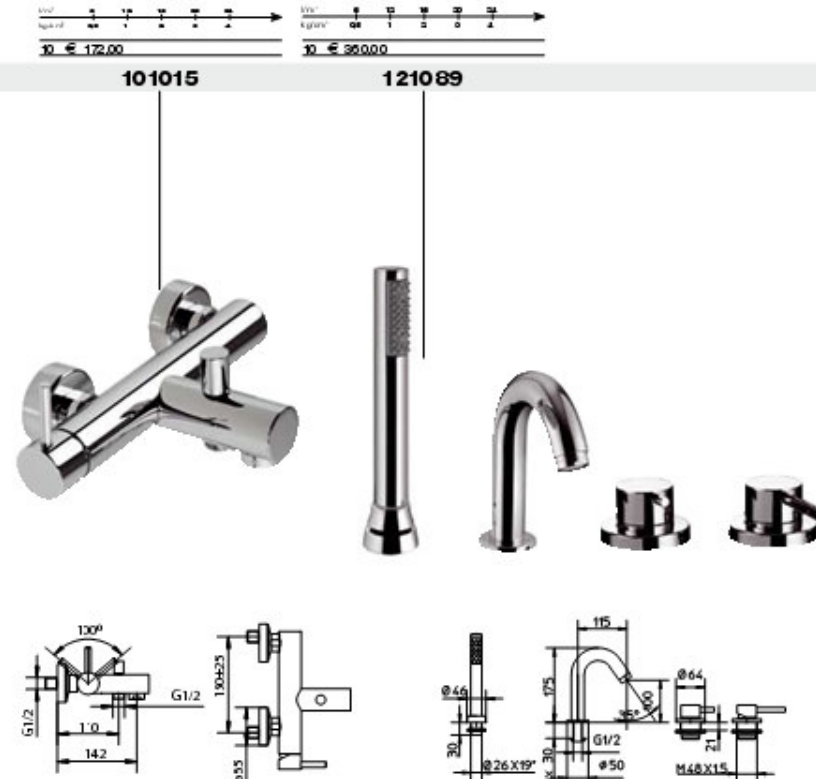
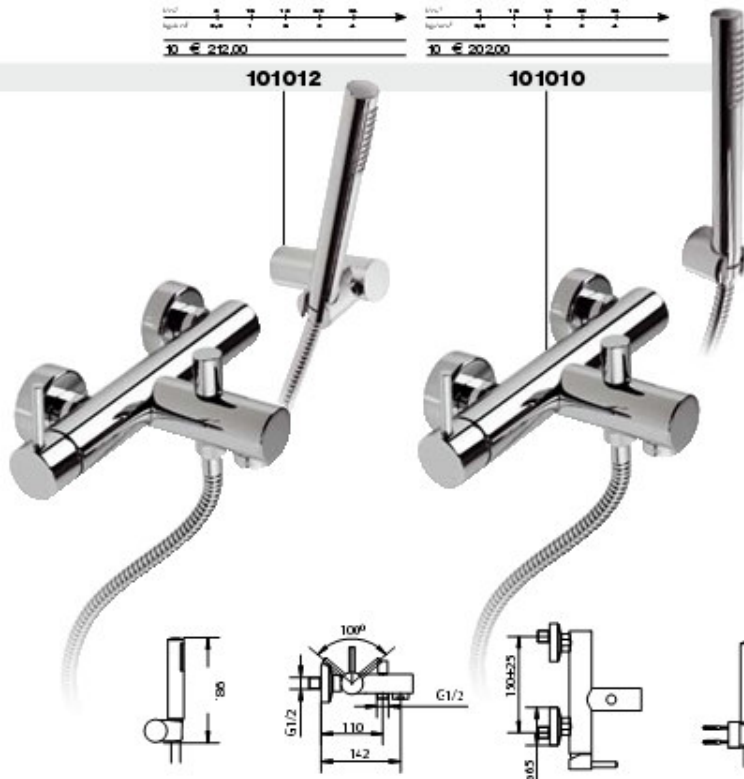

Miscelatore monocomando per doccia, appoggio orientabile, flessibile 1,5m e doccia.  
 Wall mounted shower mixer, swivel bracket, flexible tube 1,5m and handheld shower.  
 Mixture monocommande de douche, avec douche flexible 1,5m et support mural orientable.  
 Einhebelmischer als Brausehalter mit wandfluriger Brausehalter, Handbrause und Brauseschlauch 1,5m.  
 Mezclador monocomando para ducha, soporte de ducha orientable, flexible 1,5m y ducha de mano.

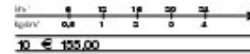

10 € 155,00

102020

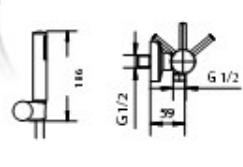

Miscelatore monocomando per doccia, senza flessibile né doccia.  
 Wall mounted shower mixer, without shower fit.  
 Mixture monocommande de douche, sans douche flexible.  
 Brausehalter/Bräusehalter, Zapfen, ohne Handbrause und ohne Brauseschlauch.  
 Mezclador monocomando para ducha, sin flexible ni ducha de mano.

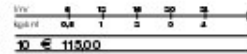

10 € 113,00

102015



Miscelatore monocomando di incasso completo per doccia.  
 Complete concealed single lever mixer for shower.  
 Mixture monocommande complet à encastrer pour douche.  
 Komplet Untersatz Brausehalter.  
 Mezclador monocomando anastable completo para ducha.

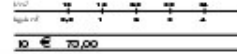

10 € 79,00

102012

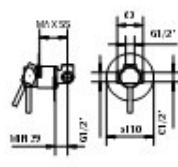

Miscelatore monocomando di incasso completo per vasca doccia con dotatore automatico.  
 Complete concealed single lever mixer for bath shower with automatic shower.  
 Mixture monocommande encastrer complet pour bain douche avec lanceur automatique.  
 Komplet Untersatz Wannenfall und Brausehalter mit Handbrause.  
 Mezclador monocomando anastable para bañera/ducha completo con dotador automático.

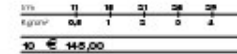

10 € 145,00

101022

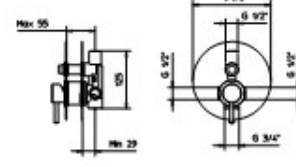

Raccordo di incasso per alimentazione flessibile a crocchetto di incasso completo di doccia flessibile.  
 Wall mounted spout for bath tub with shower flexible and shower.  
 Raccord pour flexible pour installation à encastrer avec support intégré complet de flexible et douche.  
 Anschluss für Schlauch mit Brausehalter, Brausehalter mit Handbrause.  
 Conexión para tubo flexible completo de flexible y ducha.

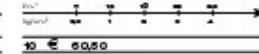

10 € 69,50

991023

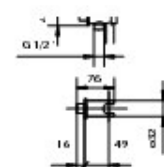

Bocca vasca nitride con anello.  
 Wall mounted spout for bath tub with anello.  
 Boc nitrid pour baignoire avec anneau.  
 Wannenfall mit Luftspindel.  
 Corno para bañera con anillo.

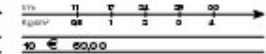

10 € 69,00

992112

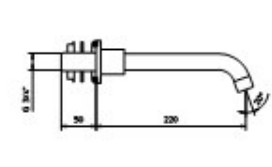

digit 2

pin pin



finiture disponibili  
available finishes  
finiten disponibili  
verfügbare Farben  
acabados disponibles

10 Cromo - Chrome  
Chromé - Chrom

Miscelatore monocomando per lavabo con acciaio da 1" 1/4.  
Single control mixer for washbasin, with 1/2" spout.  
Mixer monocomando de lavabo con acciaio 1" 1/4.  
Waschtisch Einheitsmischer mit Abtropfmutter 1" 1/4.  
Mezclador monocomando para lavabo con desagüe 1" 1/4.

Miscelatore monocomando per lavabo senza scarico.  
Single control mixer for washbasin, without waste.  
Mixer monocomando de lavabo, sans vidage.  
Waschtisch Einheitsmischer ohne Abtropfmutter.  
Mezclador monocomando para lavabo sin desagüe.

Miscelatore monocomando alto per lavabo con acciaio 1" 1/4 Click-Clack.  
Tall single control mixer for washbasin, Click-Clack waste 1" 1/4.  
Mixer monocomando de lavab. avec vidage Click-Clack 1" 1/4.  
Hoch Waschtisch Einheitsmischer mit Click-Clack Abtropfmutter 1" 1/4.  
Mezclador monocomando alto para lavabo con desagüe Click-Clack 1" 1/4.

Miscelatore monocomando alto per lavabo senza scarico.  
Tall single control mixer for washbasin, without waste.  
Mixer monocomando haut de lavabo sans vidage.  
Hoch Waschtisch Einheitsmischer ohne Abtropfmutter.  
Mezclador monocomando alto para lavabo sin desagüe.

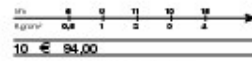

483010

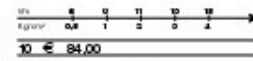

483011

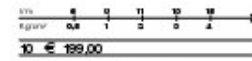
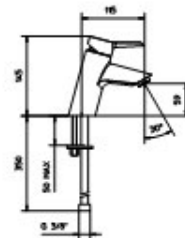
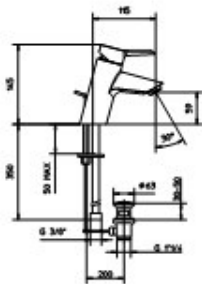

483077

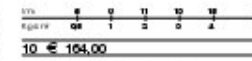
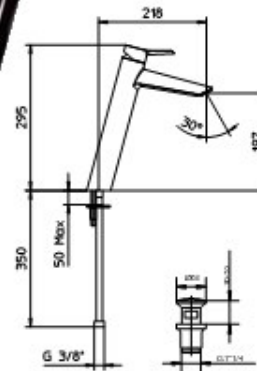
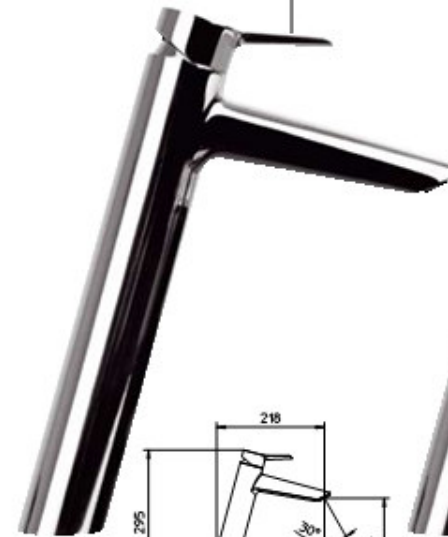

483018

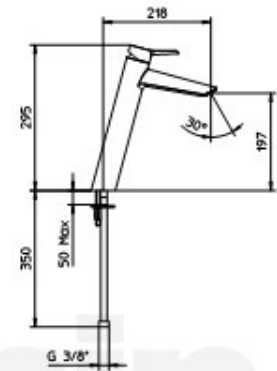
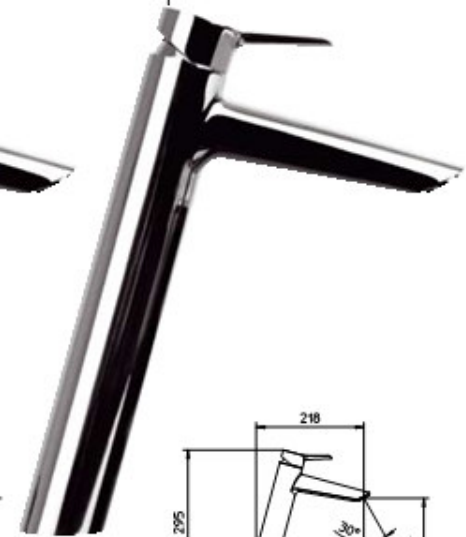

pin

pin



Miscelatore monocomando per vasca con  
doccia, supporto doccia orientabile,  
flessibile 1,5m e doccia.

Wall mounted bath shower mixer with  
shower, adjust holder with flexible 1,5m  
and handshower.

Mixer monocomando de bain douche,  
flessible 1,5m, douche et support mural  
orientable.

Einhebelmischer als Wannen/Badwanne mit  
verstellbarer Brausehalter, Handbrause und  
Duschschlauch 1,5m.

Miscelador monocomando para bañera con  
ducha, soporte de ducha orientable,  
flessible 1,5m y ducha de mano.

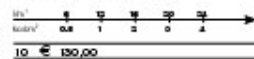

481013

Miscelatore monocomando per vasca con  
doccia, supporto doccia fissabile,  
flessibile 1,5m e doccia.

Wall mounted bath shower mixer, with  
adjust flexible holder with flexible 1,5m  
and handshower.

Mixer monocomando de bain douche,  
flessible 1,5m, douche et support mural fix.

Einhebelmischer als Wannen/Badwanne mit  
fixierbarem Handbrause und Brause-  
schlauch 1,5m.

Miscelador monocomando para bañera con  
ducha, soporte de ducha flexible 1,5m  
y ducha de mano.

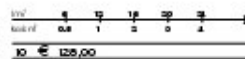

481095

Miscelatore monocomando per vasca con  
doccia, senza flessibile né doccia.

Wall mounted bath shower mixer with  
shower without shower kit.

Mixer monocomando de bain douche  
sans douche et flexible.

Einhebelmischer als Wannen/Badwanne  
ohne Handbrause und ohne Brauseschlauch.

Miscelador monocomando para bañera con  
ducha sin flexible ni ducha de mano.

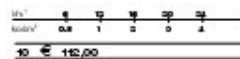

481015

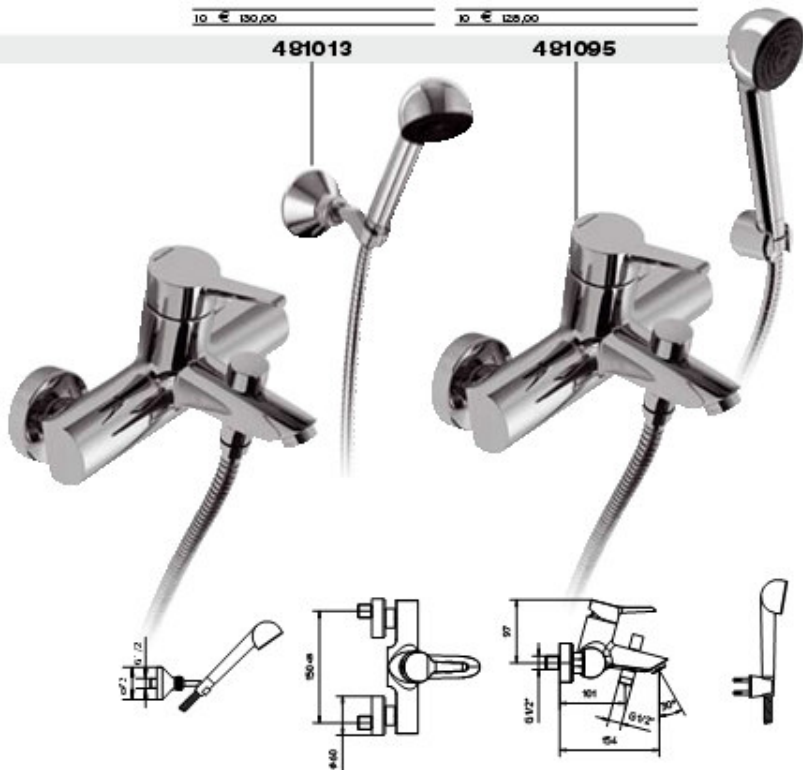

Miscelatore monocomando per doccia, appoggio orientabile, flessibile 1,5 m e doccia.

Wall mounted shower mixer, swivel bracket, flexible tube 1,5m and handshower.

Mixer à monocommande de douche avec douche, flexible 1,5m et support mural orientable.

Einhebelmischer als Brausehalter mit orientierbarem Brausekopf, Handbrause und Brauseschlauch 1,5m.

Miscelador monocomando para ducha, soporte de ducha orientable, flexible 1,5m y ducha de mano.

Miscelatore monocomando per doccia, appoggio orientabile, flessibile 1,5 m e doccia.

Wall mounted shower mixer, swivel bracket, flexible tube 1,5m and handshower.

Mixer à monocommande de douche, avec douche, flexible 1,5m et support mural orientable.

Einhebelmischer als Brausehalter mit orientierbarem Brausekopf, Handbrause und Brauseschlauch 1,5 m.

Miscelador monocomando para ducha, soporte de ducha orientable, flexible 1,5m y ducha de mano.

Miscelatore monocomando per doccia, senza flessibile né doccia.

Wall mounted shower mixer, without shower kit.

Mixer à monocommande de douche, sans douche et/ou flexible.

Einhebelmischer als Brausekopf, ohne Handbrause und ohne Brauseschlauch.

Miscelador monocomando para ducha, sin flexible ni ducha de mano.

10 € 134,00

482020

10 € 112,00

482097

10 € 94,00

482015

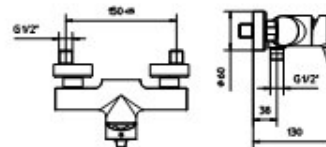
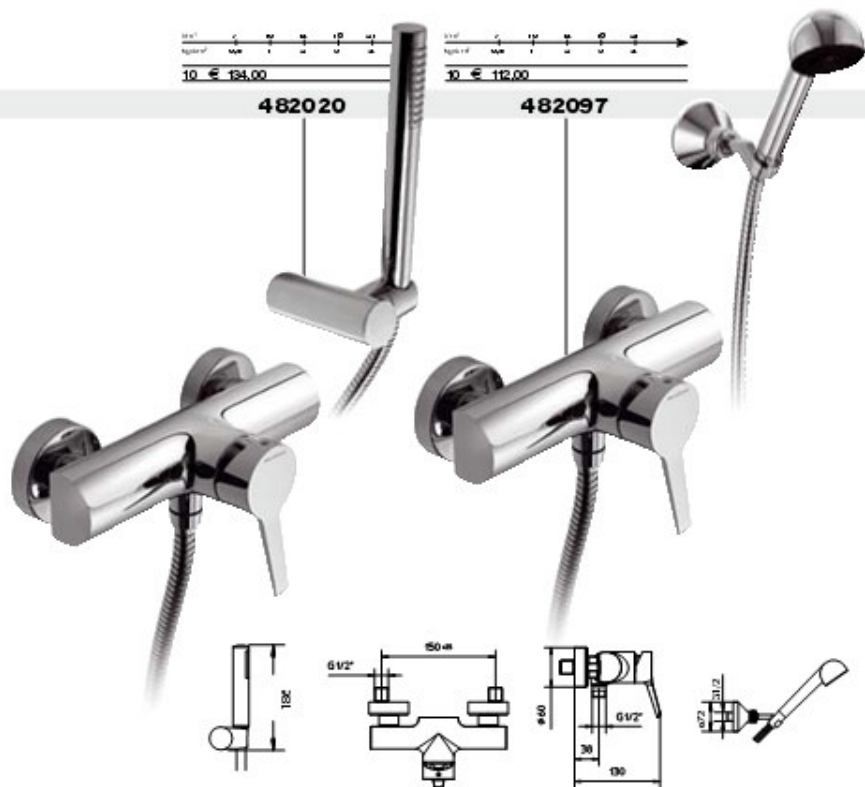

Miscelatore monocomando di incasso completo per vasca doccia con diffusore automatico.  
Complete concealed single lever mixer for bath/shower with automatic diverter.  
Mixer monocomando à encastrement complet pour bain/douche avec inverseur automatique.  
Komplet Uniputz Wannenfil und Brausebatterie mit Unistyle.  
Miscelador monocomando empotrable para bañaducha con desviador automático.

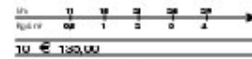

401022



UNICO 3 corpo di incasso per miscelatore monocomando vasca doccia con diffusore automatico senza parti esterne.  
UNICO 3 concealed body for bath/shower with automatic diverter without exposed parts.  
UNICO 3 corps de montage monocomando à encastrement de bain/douche avec inverseur sans parties extérieures.  
UNICO 3 Uniputz Körper für Wannenfil und Brausebatterie mit Unistyle, ohne Außenteile.  
UNICO 3 cuerpo de montaje monocomando empotrable para bañaducha con desviador automático sin partes externas.

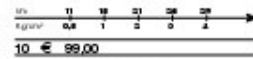

992727



Solo parti esterne per miscelatore monocomando vasca doccia con diffusore automatico.  
Exposed parts only for bath/shower concealed mixer with automatic diverter.  
Partes exteriores para mixer monocomando de bañaducha con desviador automático.  
Außenstücke Wannenfil und Brausebatterie mit Unistyle.  
Partes externas de mezclador monocomando empotrable para bañaducha con desviador automático.

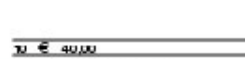

401027



Miscelatore monocomando di incasso completo per doccia.  
Complete concealed single lever mixer for shower.  
Mixer monocomando complet à encastrement pour douche.  
Komplet Uniputz Brausebatterie.  
Miscelador monocomando empotrable completo para ducha.

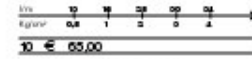

402012



UNICO 3 corpo di incasso per miscelatore monocomando per doccia, senza parti esterne.  
UNICO 3 concealed body for shower without exposed parts.  
UNICO 3 corps de montage monocomando à encastrement pour douche, sans parties extérieures.  
UNICO 3 Uniputzkörper für Brausebatterie ohne Außenteile.  
UNICO 3 cuerpo de montaje monocomando empotrable para ducha, sin partes externas.

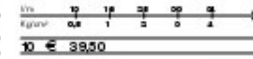

992726



Solo parti esterne per miscelatore monocomando di incasso per doccia.  
Exposed parts only for shower concealed mixer.  
Partes exteriores para mixer monocomando à encastrement pour douche.  
Außenstücke für Uniputzbrausebatterie.  
Solo partes externas para mezclador monocomando empotrable para ducha.

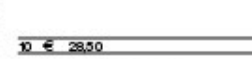

402013



Miscelatore monocomando di incasso completo per doccia in POLIPROPILENE.  
POLIPROPILENE concealed complete shower mixer.  
Mixer monocomando à encastrement pour douche complet en POLIPROPILENE.  
Uniputz Einlehebrause komplet für Dusche aus POLIPROPILENE.  
Miscelador monocomando empotrable completo para ducha de POLIPROPILENE.

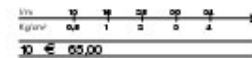

482912



992732

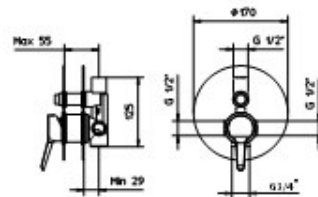
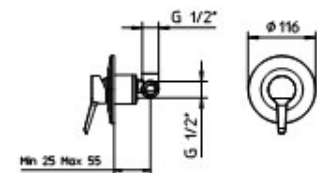



finiture disponibili  
available finishes  
finitten disponibiles  
verfügbare Farben  
acabados disponibles

---

10 Cromo - Chrome  
Chromé - Chrom



Miscelatore monocomando per lavabo con scarico di 1" 1/4.  
Single control mixer for washbasin, with pop-up waste 1" 1/4.  
Mixer monocomando de lavabo, avec vidage 1" 1/4.  
Waschtisch Einhebelmischer mit Abflusganitur 1" 1/4.  
Mezclador monocomando para lavabo con desagüe 1" 1/4.

Miscelatore monocomando per bidet con scarico 1" 1/4.  
Single control mixer for bidet, with pop-up waste 1" 1/4.  
Mixer monocomando de bidet, avec vidage 1" 1/4.  
Bidet Einhebelmischer mit Abflusganitur 1" 1/4.  
Mezclador monocomando para bidet con desagüe 1" 1/4.

Miscelatore monocomando per vasca con doccia, supporto doccia orientabile, flessibile 1,5m e doccia.  
Wall mounted bath-shower mixer, with shower, adjust bracket with flexible tube 1,5m and handshower.  
Mixer monocomando de bain douche, flexible 1,5m, douchette et support mural orientable.  
Einhebelmischer als Wannen- / Badtulle mit verstellbarer Brausehalter, Handbrause, und Duschschlauch 1,5 m.  
Mezclador monocomando para bañera con ducha, soporte de ducha orientable, flexible 1,5m y ducha de mano.

Miscelatore monocomando per vasca con doccia, supporto doccia fisso, flessibile 1,5m e doccia.  
Wall mounted bath-shower mixer, with shower, fixed bracket with flexible tube 1,5m and handshower.  
Mixer monocomando de bain douche, flexible 1,5m, douchette et support mural fixe.  
Einhebelmischer als Wannen- / Badtulle mit festem Brausehalter, Handbrause, und Duschschlauch 1,5m.  
Mezclador monocomando para bañera con ducha, soporte de ducha fijo, flexible 1,5m y ducha de mano.

Miscelatore monocomando per vasca con doccia, senza flessibile né doccia.  
Wall mounted bath-shower mixer with shower, without shower fl.  
Mixer monocomando de bain douche sans douchette ni flexible.  
Einhebelmischer als Wannen- / Badtulle ohne Brausehalter.  
Mezclador monocomando para bañera con ducha, sin flexible ni ducha de mano.

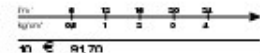
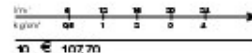
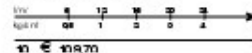
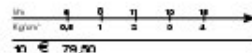
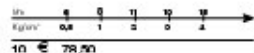

473010

474010

471012

471010

471015

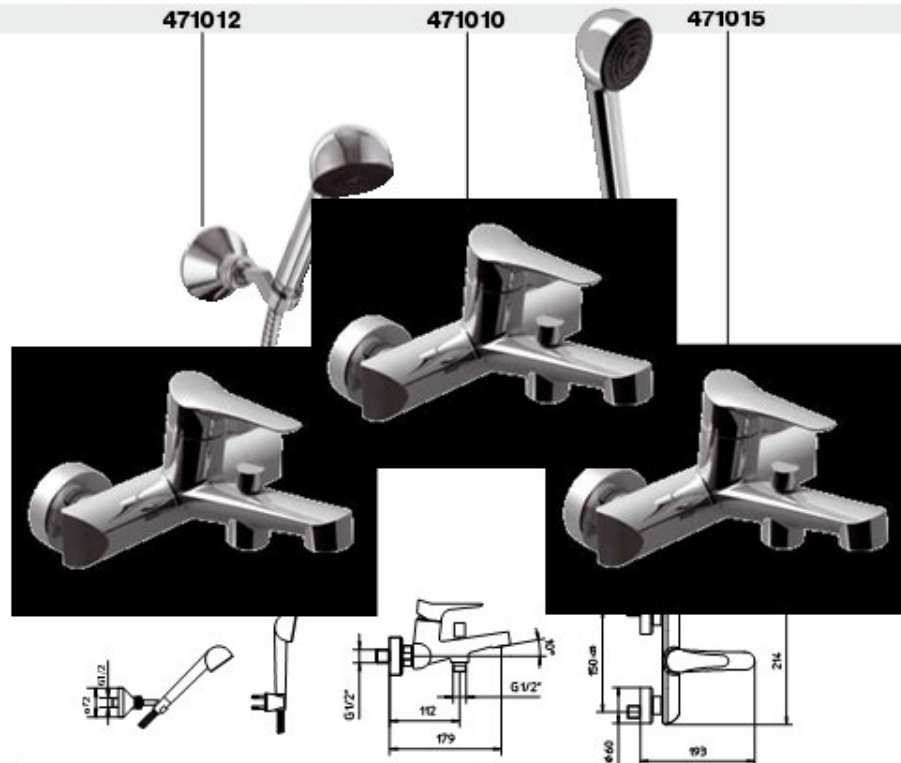
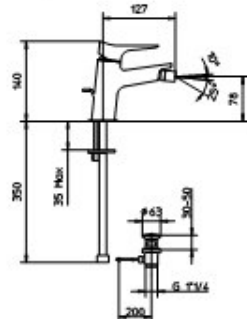
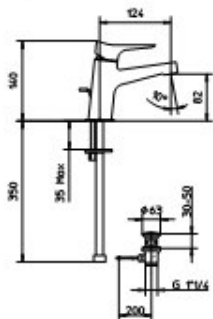

flap



Miscelatore monocomando per doccia, appoggio orientabile, flessibile 1,5m e doccia.  
 Wall mounted shower mixer, swivel bracket, flexible tube 1,5m and handheld shower.  
 Mijetar monocomanda de datche avec douchette, flexible 1,5m et support mural orientable.  
 Einzelmischer als Batterschale mit verschiebbarem Brausenohr, Handbrause und Batterschlauch 1,5m.  
 Mezclador monocomando para ducha, soporte de ducha orientable, flexible 1,5m y ducha de mano.

Miscelatore monocomando per doccia, senza flessibile né doccia.  
 Wall mounted shower mixer, without shower kit.  
 Mijetar monocomanda de datche sans douchette ni flexible.  
 Brauserfahrbadmischer, Aufsatz ohne Handbrause und ohne Batterschlauch.  
 Mezclador monocomando para ducha, sin flexible ni ducha de mano.

Miscelatore monocomando di incasso completo per vasca doccia con dotatore automatico.  
 Complete concealed single lever mixer for bath/shower with automatic diverter.  
 Mijetar monocomanda a incasso complet pour bain/douchette avec diviseur automatique.  
 Komplet Unterputz-Wannenfüll und Brausermischer mit Duschrohr.  
 Mezclador monocomando empotrable completo para bañera/ducha con chaveta automática.

Miscelatore monocomando di incasso completo per doccia.  
 Complete concealed single lever mixer for shower.  
 Mijetar monocomanda complet a incasso pour douche.  
 Komplet Unterputz Brausermischer.  
 Mezclador monocomando empotrable completo para ducha.

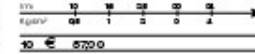
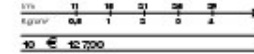
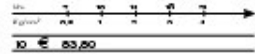
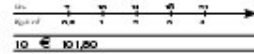

472020

472015

471020

472010

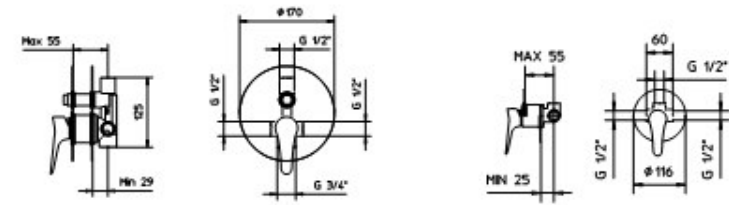
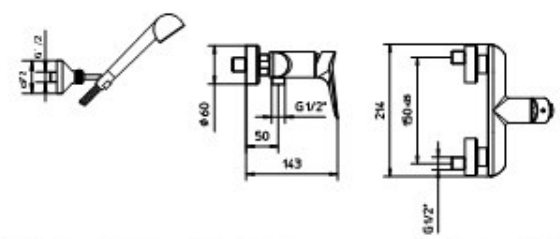

flap flap